

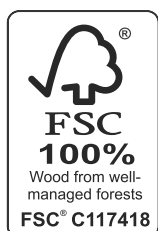

Jura
50153066

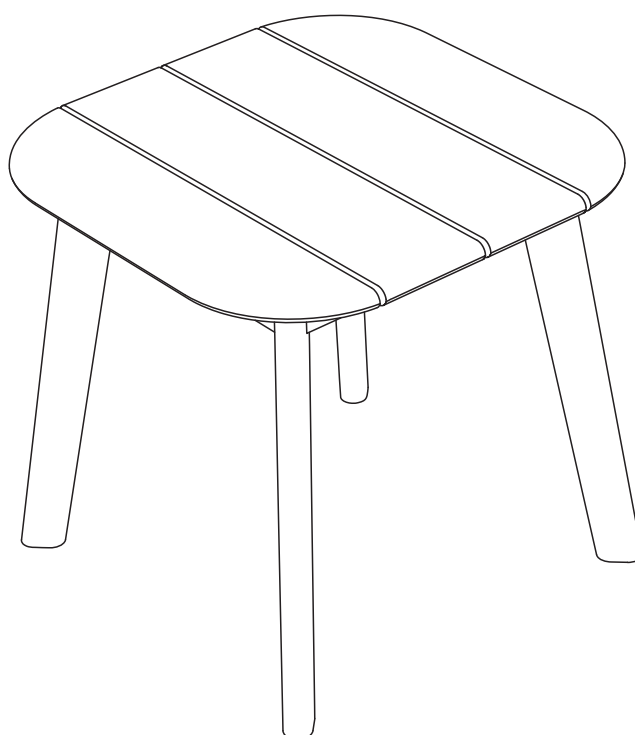
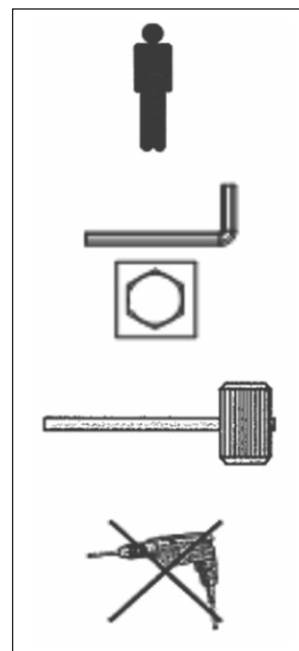
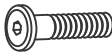
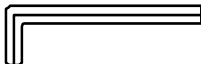

Le Sud B.V.
PO BOX 43 4940 AA
The Netherlands

| | | | |
|---|---|-----------|---|
| A |  | M6 x 30 | 8 |
| B |  | Allen key | 1 |

1 = 4x

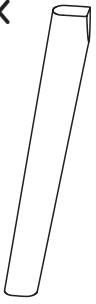

2 = 1x

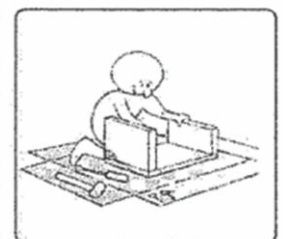
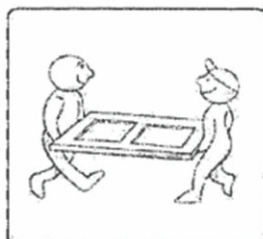
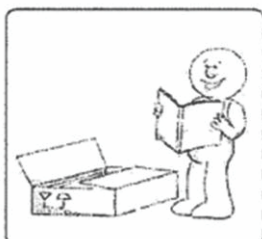
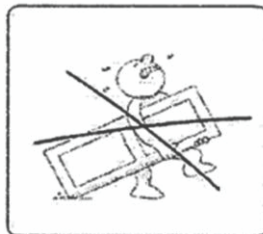
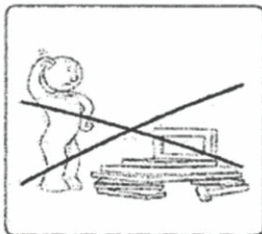
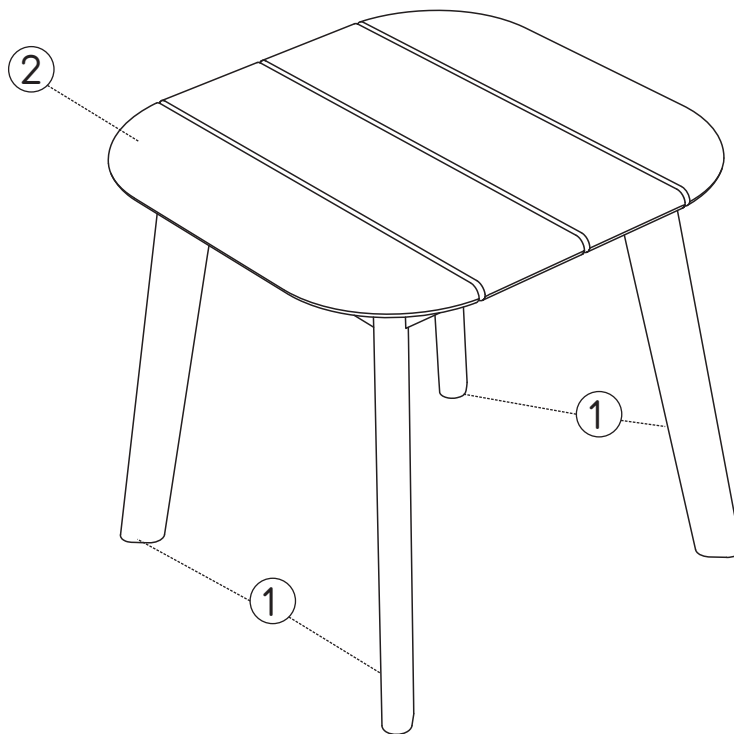
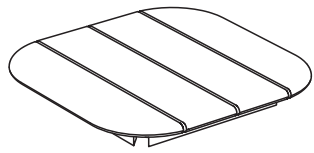

01

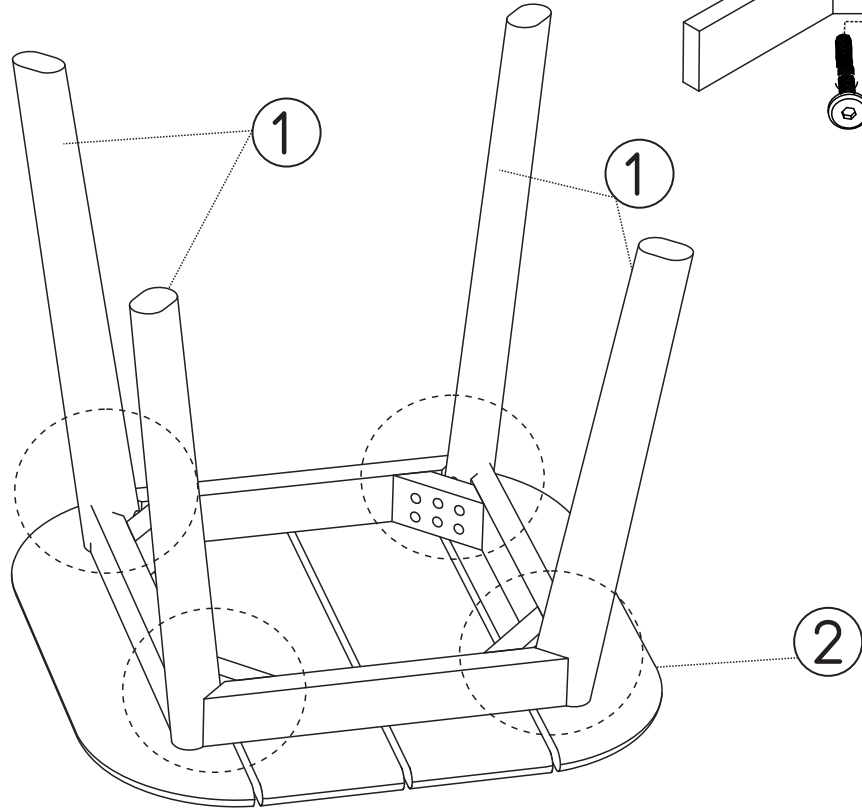

02

